

Product Summary

$V_R = 900\text{ V}$
 $I_F = 42\text{ A}$ ($T_C=141^\circ\text{C}$)
 $Q_c = 145\text{ nC}$ ($V_R=600\text{ V}$)

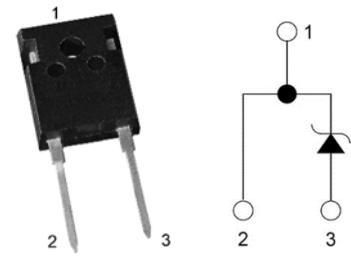

TO-247-2

Features

- Zero Forward/Reverse Recovery Current
- High Blocking Voltage
- High Frequency Operation
- Positive Temperature Coefficient on V_F
- Temperature Independent Switching Behavior
- High surge current capability
- 100% avalanche tested

Benefits

- Higher System Efficiency
- Parallel Device Convenience without thermal runaway
- Higher Temperature Application
- No Switching loss
- Hard Switching & Higher Reliability
- Environmental Protection

Applications

- Motor Drives
- Solar Inverters
- AC/DC converters
- DC/DC converters
- Uninterruptable power supplies

Maximum Ratings ($T_C=25^\circ\text{C}$ unless otherwise specified)

| Parameter | Symbol | Test conditions | Value | Unit |
|---------------------------------------|-----------|--|------------|------------------|
| Peak Repetitive Reverse Voltage | V_{RRM} | | 900 | V |
| Continuous Forward Current | I_F | $T_C=25^\circ\text{C}$ | 100 | A |
| | | $T_C=130^\circ\text{C}$ | 50 | |
| | | $T_C=141^\circ\text{C}$ | 42 | |
| Non repetitive Forward Surge Current | I_{FSM} | $T_C = 25^\circ\text{C}$, $t_p=10\text{ ms}$, Half Sine Pulse | 280 | A |
| | | $T_C = 110^\circ\text{C}$, $t_p=10\text{ ms}$, Half Sine Pulse | 260 | |
| Repetitive peak Forward Surge Current | I_{FRM} | $T_C = 25^\circ\text{C}$, $t_p=10\text{ ms}$, Freq = 0.1Hz, 100 cycles, Half Sine Pulse | 260 | A |
| | | $T_C = 110^\circ\text{C}$, $t_p=10\text{ ms}$, Freq = 0.1Hz, 100 cycles, Half Sine Pulse | 240 | |
| Total power dissipation | P_D | $T_C=25^\circ\text{C}$ | 375 | W |
| | | $T_C=110^\circ\text{C}$ | 163 | |
| Single Pulse Avalanche Energy | E_{AS} | $L=2\text{mH}$, $I_{AS}=13\text{A}$ | 144 | mJ |
| Diode dv/dt ruggedness | dv/dt | $V_R = 0\text{-}900\text{V}$ | 80 | V/ns |
| Operating Junction Temperature | T_J | | -55 to 175 | $^\circ\text{C}$ |
| Storage Temperature | T_{STG} | | -55 to 175 | $^\circ\text{C}$ |

Stresses exceeding those listed in the Maximum Ratings table may damage the device. If any of these limits are exceeded, device functionality should not be assumed, damage may occur and reliability may be affected.

Electrical Characteristics

| Parameter | Symbol | Test conditions | Min | Typ | Max | Unit |
|-------------------------|----------|--|-----|------|------|---------|
| DC Blocking Voltage | V_{DC} | $T_J = 25^\circ C$ | 900 | | | V |
| Forward Voltage | V_F | $I_F = 42A, T_J = 25^\circ C$ | | 1.4 | 1.75 | V |
| | | $I_F = 42A, T_J = 125^\circ C$ | | 1.65 | | |
| | | $I_F = 42A, T_J = 175^\circ C$ | | 1.81 | | |
| Reverse Current | I_R | $V_R = 900V, T_J = 25^\circ C$ | | 5 | 100 | μA |
| | | $V_R = 900V, T_J = 125^\circ C$ | | 20 | | |
| | | $V_R = 900V, T_J = 175^\circ C$ | | 60 | | |
| Total Capacitive Charge | Q_C | $V_R = 600V, T_J = 25^\circ C$ | | 145 | | nC |
| Total Capacitance | C | $V_R = 1V, T_J = 25^\circ C,$ Freq = 1MHz | | 1970 | | pF |
| | | $V_R = 300V, T_J = 25^\circ C,$ Freq = 1MHz | | 182 | | |
| | | $V_R = 600V, T_J = 25^\circ C,$ Freq = 1MHz | | 146 | | |

Note: This is a majority carrier diode, so there is no reverse recovery charge

Thermal Characteristics

| Parameter | Symbol | Condition | Min | Typ | Max | Unit |
|--------------------|---------------|---------------|-----|-----|-----|--------------|
| Thermal Resistance | $R_{th(j-c)}$ | junction-case | | 0.4 | | $^\circ C/W$ |

Typical Electrical Curves

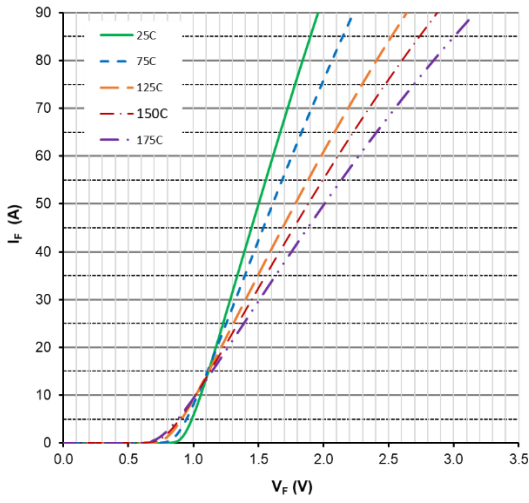

Figure 1. Forward Characteristics

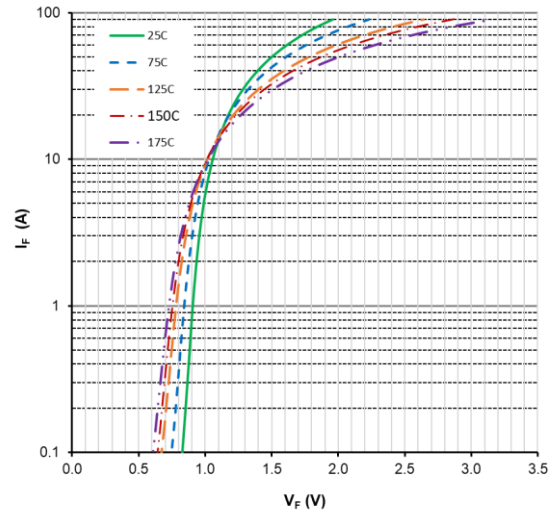

Figure 2. Forward Characteristics

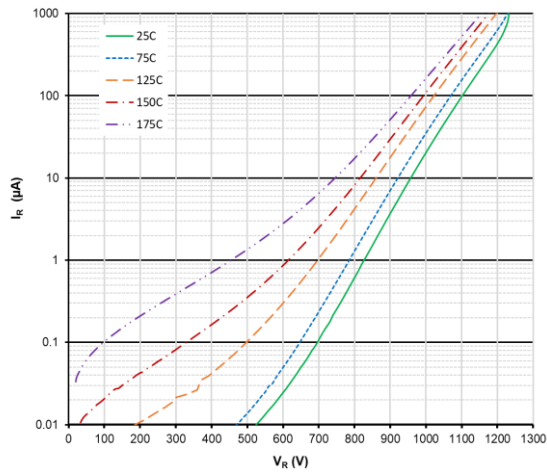

Figure 3. Reverse Characteristics

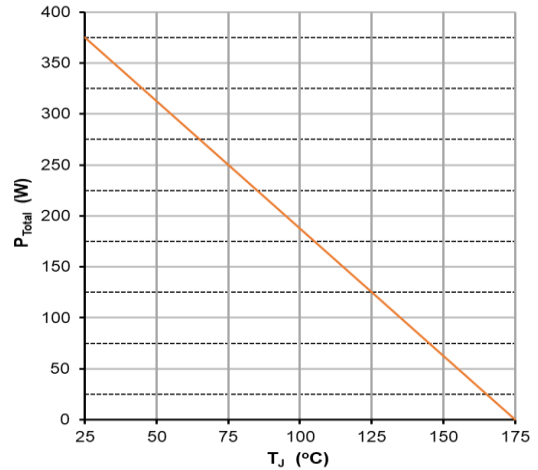

Figure 4. Power Derating

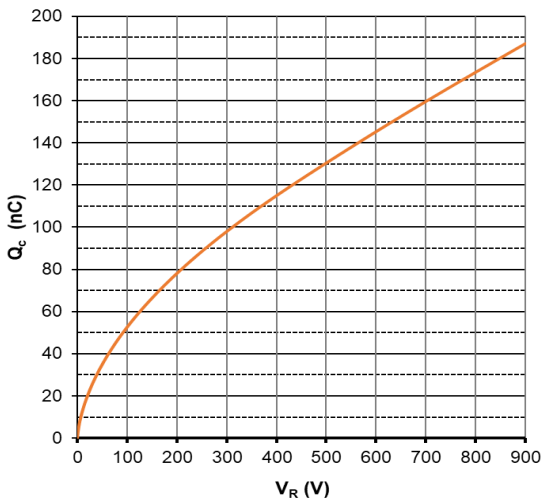

Figure 5. Reverse charge vs. Reverse Voltage

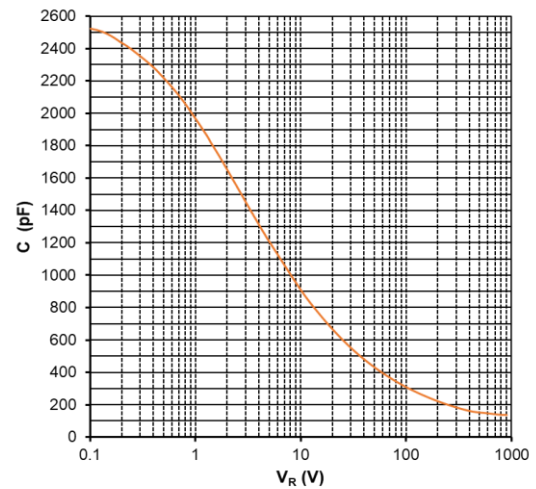

Figure 6. Capacitance vs. Reverse Voltage

Typical Electrical Curves (Per Leg)

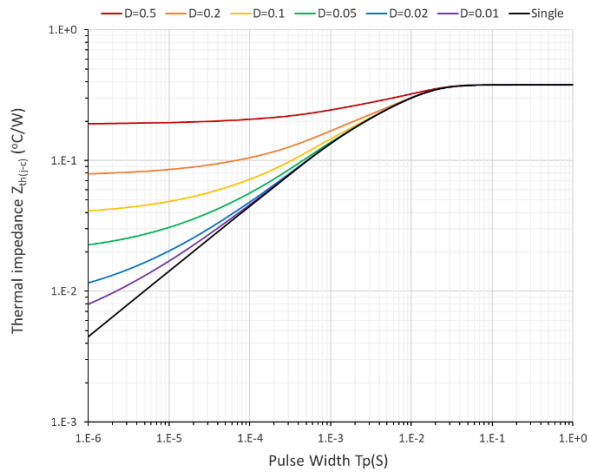

Figure 7. Transient Thermal Impedance

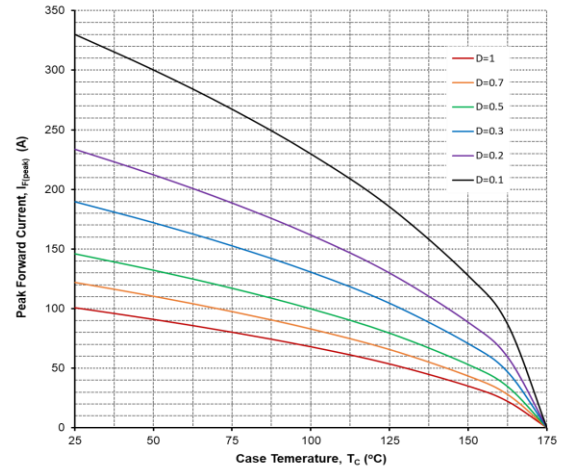
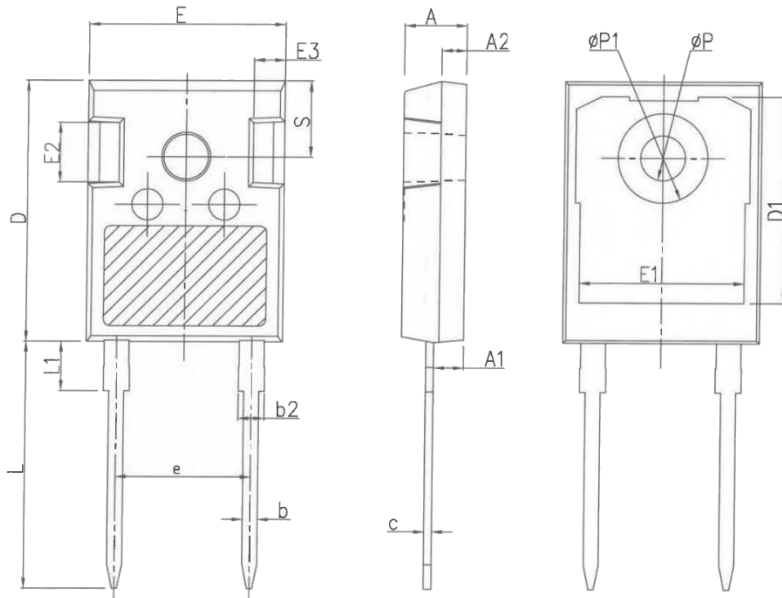

Figure 8. Current Derating

Package Dimensions

(TO-247-2 Package)



| SYMBOL | mm | |
|--------|----------|-------|
| | MIN. | MAX. |
| A | 4.8 | 5.20 |
| A1 | 2.21 | 2.59 |
| A2 | 1.85 | 2.15 |
| b | 1.11 | 1.36 |
| b2 | 1.91 | 2.21 |
| c | 0.51 | 0.75 |
| D | 20.70 | 21.30 |
| D1 | 16.25 | 16.85 |
| E | 15.50 | 16.10 |
| E1 | 13.00 | 13.60 |
| E2 | 4.80 | 5.20 |
| E3 | 2.30 | 2.70 |
| e | 10.88BSC | |
| L | 19.62 | 20.22 |
| L1 | - | 4.30 |
| φP | 3.4 | 3.80 |
| φP1 | - | 7.30 |
| S | 6.15BSC | |

| Part Number | Package | Packing | Marking |
|--------------|----------|--------------|--------------|
| A3D42PA090AN | TO-247-2 | 30pcs / Tube | A3D42PA090AN |